

# Interoperabilität im Datenaustausch der Energiewirtschaft

vom Use Case zum Test der Integrationsprofile

Dipl.-Ing. Dr. techn.  
**Gerald FRANZL**  
systems engineer

**AICO EDV-Beratung GmbH**  
Office Vienna, 1030 Wien, Marxergasse 24/2/601  
www.aico.software

15. Symposium Energieinnovation 2018 — Graz — 15. Februar 2018

- The Energy System
  - Integrating the Energy System
    - Interoperability
    - IES Process
  - Integration Profile Development
    - Use Case Method
    - Technical Frameworks
  - Interoperability Testing
    - Test Results
    - Other Activities

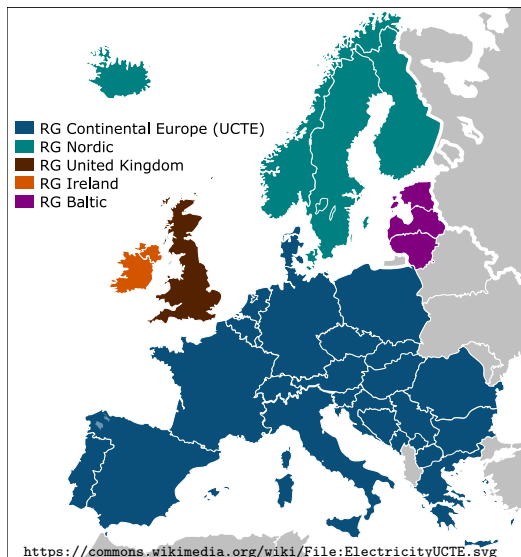

- the biggest machine
- distributed control
- **supply = demand** at any instance of time
- voltage & frequency propagate @ light-speed
- hard to grasp

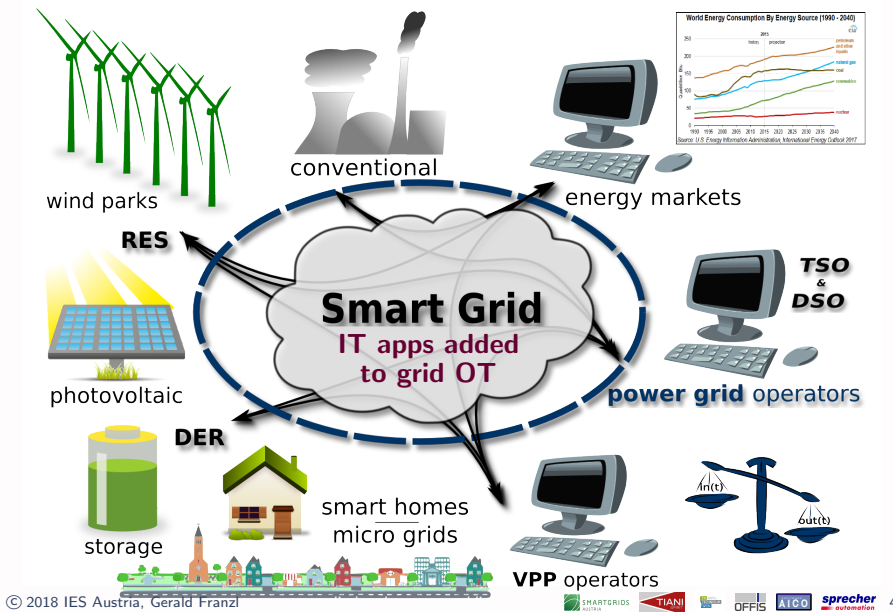

Integration of:

- renewable energy sources — fluctuating energy production
- distributed energy resources — many connected to LV/MV grid
- prosumer interfaces and control systems — many different

Improve the:

- grid utilisation — reduce overprovisioning
- supply quality, system resilience, etc. — new options
- share of renewable energy sources — energy transition

→ Smart Grids enable novel approaches — **step-by-step**

- energy system includes more-and-more networked IT → becomes *smart*
- reaches into customer premises enabling novel business models
- increased number of actors and products that interact
- reliable communication to maintain coordinated control
- various actors served in parallel → multiple access
- open *interoperability* becomes a key issue

Projekt targets are:

1. Migrate an established holistic process that fosters interoperable solutions
2. Adopt a testplattform to assess interoperability and required conformances
3. Highlight economic chances and benefits of interoperably solutions
4. Realise prototype building blocks for initial interoperability testing
5. Invite stakeholders to jointly develop integration profiles

**IES** | Integrating  
the  
Energy System

Definition of **interoperability**: "Ability of a system to work with or use the parts or equipment of another system"

<https://www.merriam-webster.com/dictionary/interoperability>

work together ⇔ communicate + understand + know + trust

- **Legal** — joint conformity with laws, policies, standards, regulations
- **Semantic** — equal meaning and interpretation of content
- **Syntactical** — use common data formats and encoding
- **Technical** — select the same communication means and protocols
- **Operational** — provide required information at the right time

Smart Grid Architecture Model – SGAM

Use it to:

- position the many features in a map
- identify relations and interfaces
- encapsulate building blocks

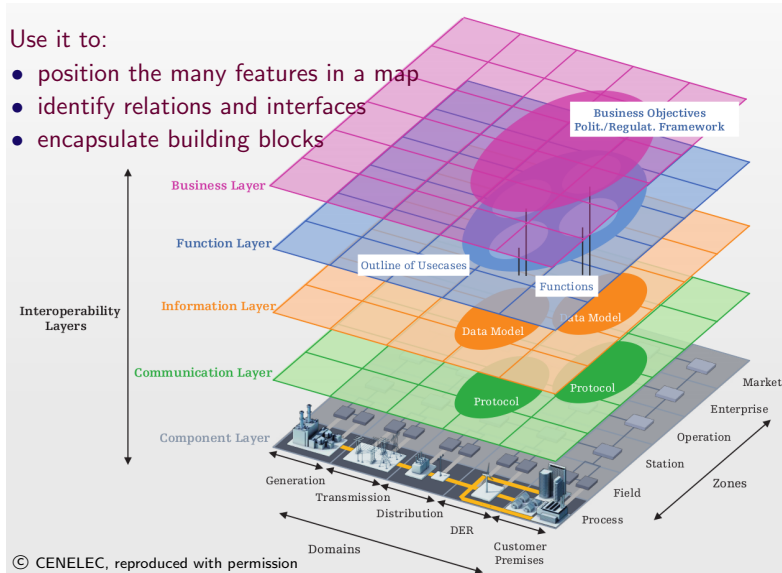

© CENELEC, reproduced with permission

Identify Use Cases – VPP – send Schedule

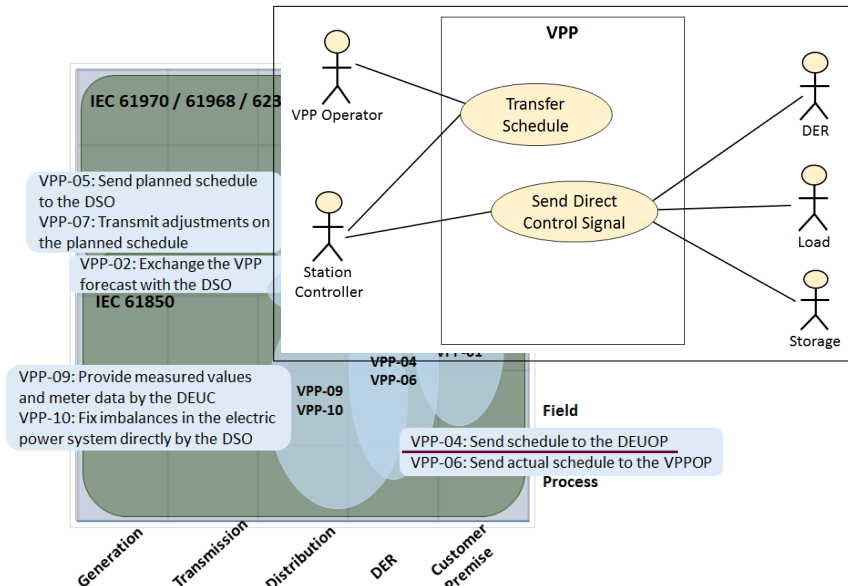

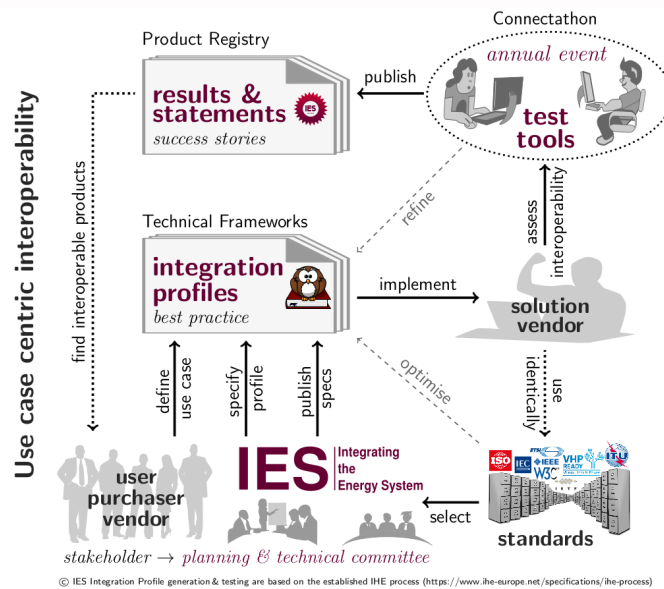

[https://wiki.ihe.net/index.php/Technical\\_Framework\\_Publication\\_Process](https://wiki.ihe.net/index.php/Technical_Framework_Publication_Process)

May: Starting point for development of new profiles

- October: **Webinar** to prepare for the IES-Plugfest
- November: **IES Virtual Plugfest** for trial implementation
- December: **Registration** opens for testing events @ Connectathon-Energy
- Spring: **Connectathon-Energy**
- May: Starting point for development of new profiles

... and so on and so forth ...

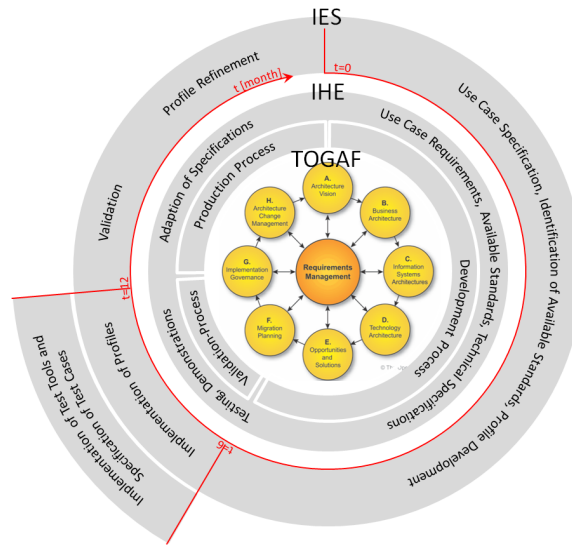

## TOGAF

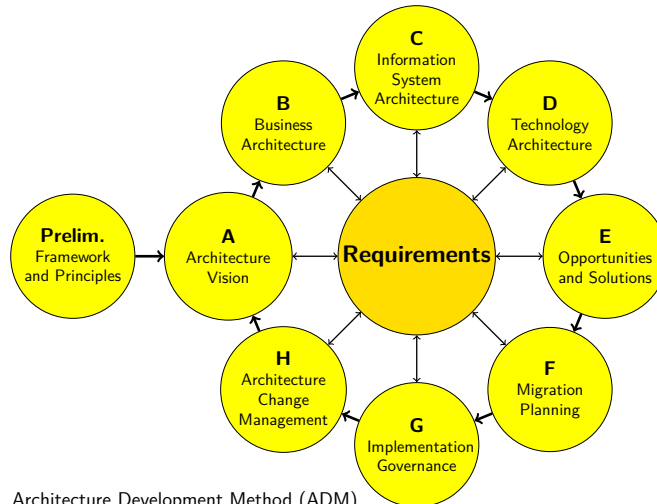

Architecture Development Method (ADM)  
The Open Group Architecture Framework (TOGAF)

<http://pubs.opengroup.org/architecture/togaf9-doc/arch/>

## Technical Specification – send Schedule

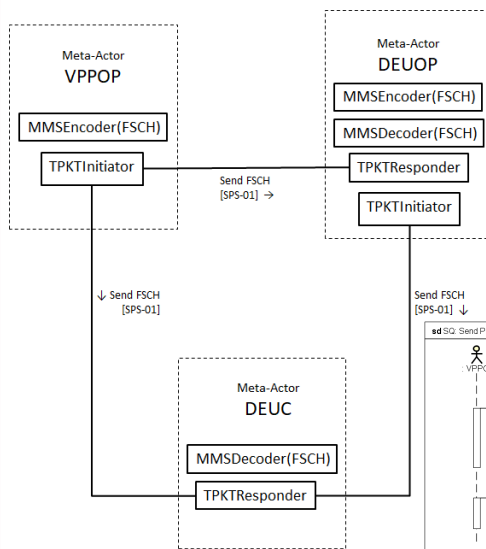

Actor-Transaction diagram

- compose meta-actors from 'atomic' actors (software modules)
- connection between actors = transaction (cooperation via ICT)

- split transaction into 'atomic' steps (arrows indicate process flow not information flow direction)

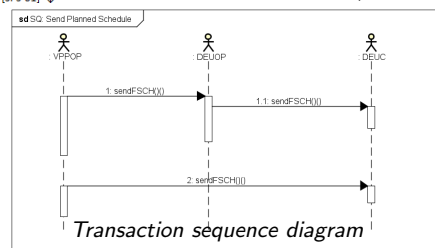

Transaction sequence diagram

Domain Overview

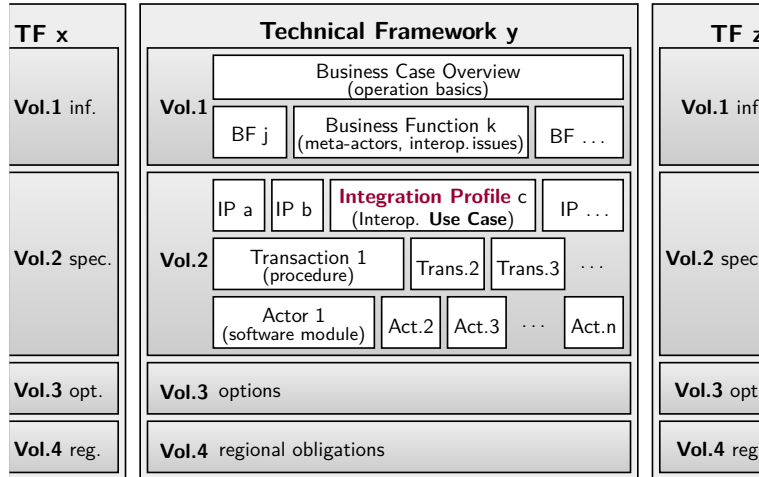

Implementation

IT solutions (systems, sub-systems, modules)  
are implemented by vendors – entirely on their own

Integration Profiles are used as implementation guidelines  
to achieve prototypes that pass interoperability testing

Connectathon

<https://www.ihe-europe.net/testing-IHE/connectathon>

[https://www.ihe-europe.net/sites/default/files/Flyer\\_Gazelle\\_03.pdf](https://www.ihe-europe.net/sites/default/files/Flyer_Gazelle_03.pdf)

- provides test szenarios and sequences: *step-by-step*
- documents the results when executed by a neutral *monitor*
- can include *validators* for conformity checks
- *proxy server* records test-specifically all data-traffic
- and much more . . .

[https://connectathon-results.ihe.net/view\\_result.php](https://connectathon-results.ihe.net/view_result.php)



IHE Integration Statement			
Vendor	Product Name	Version	Date
Tiani "Spirit" GmbH - Cisco Systems Inc.	SpiritEHR_4.0	4.0	3/3/17

This product implements all transactions required in the IHE Technical Framework to support the IHE Integration Profiles, Actors and Options listed below :

Integration Profile	Actor	Integration Profile Option
Cross Enterprise User Assertion	X-Service User	None
Cross Enterprise User Assertion	X-Service User	Authz-Consent
Cross Enterprise User Assertion	X-Service User	Subject-Role

Internet address for vendor's IHE information :  
[http://www.tiani-spirit.com/documents/IS\\_Europe.pdf](http://www.tiani-spirit.com/documents/IS_Europe.pdf)

Links to Standards Conformance Statements for the Implementation	
HL7	
DICOM	

Link to general information on IHE : [www.ihe.net](http://www.ihe.net)

[https://docs.wixstatic.com/ugd/8265f0\\_66627a7c3ae14b5ea977506f915240a4.pdf](https://docs.wixstatic.com/ugd/8265f0_66627a7c3ae14b5ea977506f915240a4.pdf)

- Vendors and users of energy system components work together to transparently specify interoperable ICT solutions
- Energy systems are easily composed and sustainably adopted step-by-step with components off the shelf
- Technical and procedural hassles are removed such that every prosumer participates in the energy transition

### EIF "The New European Interoperability Framework"

- [https://ec.europa.eu/isa2/eif\\_en](https://ec.europa.eu/isa2/eif_en)
- [https://ec.europa.eu/isa2/actions\\_en](https://ec.europa.eu/isa2/actions_en)
  - 2016.03 Big Data for Public Administrations
  - 2016.05 European public procurement interoperability initiative (e-procurement and e-invoicing)
  - 2016.19 Trusted Exchange Platform (e-TrustEx)
  - 2016.25 Interoperability Test Bed (ITB)
  - 2016.26 Interoperability agreements on electronic documents and electronic files
  - 2016.32 European Interoperability Architecture (EIA)
- [https://ec.europa.eu/isa2/solutions\\_en](https://ec.europa.eu/isa2/solutions_en)
  - EIRA and CarTool
  - Joinup
  - European Single Procurement Document (ESPD)
  - e-Documents Reference Architecture
  - Interoperability Test Bed

### EDA "Energiewirtschaftlicher Datenaustausch"

- <https://oesterreichsenergie.at/energiewirtschaftlicher-datenaustausch.html>
- [http://www.eutilities.at/go\\_international?](http://www.eutilities.at/go_international?)

Thank you for your attention

join us for coming activities

- - - [www.iesaustria.at](http://www.iesaustria.at) - - -

Dipl.-Ing. Dr. techn.  
**Gerald Franzl**  
systems engineer  
AICO EDV-Beratung GmbH

Office Vienna:  
Marxergasse 24/2/601  
1030 Vienna, Austria

franzl@aico-software.at  
www.aico-software.at

The IES-Austria team are:

- Technology Platform Smart Grids Austria  
1060 Vienna, Austria
- Tiani Spirit GmbH  
1220 Vienna, Austria
- FH Technikum Wien  
1200 Vienna, Austria
- OFFIS e.V.,  
26121 Oldenburg, Germany
- AICO EDV-Beratung GmbH  
2122 Ulrichskirchen, Austria
- Sprecher Automation GmbH  
4020 Linz, Austria

